

**CHARTER TOWNSHIP OF GARFIELD
ZONING BOARD OF APPEALS MEETING**

Thursday, January 16, 2025 @ 6:00 p.m.
Garfield Township Hall
3848 Veterans Drive
Traverse City, MI 49684

A G E N D A

ORDER OF BUSINESS

Call meeting to order
Pledge of Allegiance
Roll call of Board Members

1. Review and approval of the Agenda and declaration of a Conflict of Interest
2. Election of Officers
3. Minutes – November 21, 2024
4. Unfinished Business
 - a. A request made by Randy Guild for a six (6) ft variance from the side setback requirements. The specific request is asking for a variance from ten (10) ft to four (4) ft to allow construction of an addition to an existing dwelling along the north side lot line. The property is zoned R-1 Single Family Residential and is currently used as single-family residential. The property is located at 1571 Lake Drive with a property number of 05- 295-025-00
5. Other Business
 - a. Approve 2025 Meeting Schedule
6. Items for next agenda
7. Public Comment
8. Adjournment

The Garfield Township Board will provide necessary reasonable auxiliary aids and services, such as signers for hearing impaired and audio tapes of printed materials being considered at the meeting to individuals with disabilities upon the provision of reasonable advance notice to the Garfield Township Board. Individuals with Disabilities requiring auxiliary aids or services should contact the Garfield Township Board by writing or calling Lanie McManus, Clerk, Ph: (231) 941-1620.

**CHARTER TOWNSHIP OF GARFIELD
ZONING BOARD OF APPEALS
MEETING MINUTES
November 21, 2024**

Call to Order: Chair Smith called the meeting to order at 6:00pm.

Pledge of Allegiance: Recited by everyone in attendance.

Roll Call of Board Members:

Members Present: Robert Fudge, Scott Swan, Fern Spence, Kent Rozycki, and Rick Smith

Also in Attendance: Zoning Administrator Mike Green

1. Review and Approval of the Agenda – Conflicts of Interest (6:01)

Swan moved and Fudge seconded to approve the agenda as presented.

Yeas: Swan, Fudge, Rozycki, Spence, Smith

Nays: None

2. Review and Approval of Meeting Minutes – October 17, 2024 (6:02)

Swan moved and Fudge seconded to approve the minutes of October 17, 2024 as presented.

Yeas: Swan, Fudge, Rozycki, Spence, Smith

Nays: None

3. Public Hearings (6:01)

- a. A request has been made by Randy Guild for a six (6) foot variance from the ten (10) foot side yard setback, resulting in a four (4) foot setback for a proposed addition.**

The parcel is located within the Silver Pines Resort subdivision and is described as Lots 25 & 26 excluding the north twenty-five (25) feet thereof. The property is zoned R-1 One Family Residential, and is located at 1571 Lake Drive, with a property number of 05-295-025-00. Adjacent properties within the subdivision and surrounding areas are also zoned R-1 One Family Residential. According to Township records and information supplied by the application, the property contains a dwelling with an attached garage along with a detached accessory building. Applicant Randy Guild addressed the board and thanked them for allowing him to come before the ZBA with his request. Guild stated that they wish to expand their master bedroom over a space which is presently a deck off of the NW corner of the home. There would be no foundation changes or changes in topography. Guild stated that the property is non-conforming and was built 4-6 feet from the property line at the time it was built. He has tried unsuccessfully to purchase the empty lot next to his. The adjacent lot provides a buffer between lots and is only 25 feet wide which

Guild believes is unbuildable. Guild stated that an addition on the SW corner of the home is possible, but cost prohibitive. Zoning Administrator Green stated that neighboring vacant lot is a legal lot and he cannot say it is unbuildable. The board suggested that Guild work something out with the neighbor who owns the 25-foot lot. Board members suggested an easement. Stormwater runoff was also addressed and could be an issue if more roofline were added to the home.

Rozycki moved and Spence seconded to table the application so that the applicant could discuss a possible easement with the neighbor.

*Yeas: Rozycki, Spence, Swan, Fudge, Smith
Nays: None*

4. Unfinished Business

None

5. Other Business (6:27)

None

6. Items for Next Agenda (6:27)

None

7. Public Comment

None

8. Adjournment: *Swan moved and Fudge seconded to adjourn the meeting at 6:28pm.*

Lynn Fricke, Secretary



Charter Township of Garfield

Grand Traverse County

3848 VETERANS DRIVE
TRAVERSE CITY, MICHIGAN 49684
PH: (231) 941-1620 • FAX: (231) 941-1588

ZONING BOARD OF APPEALS STAFF REPORT

Meeting Date: Thursday, January 16, 2025
Case #: 2024-05 Section 313.E side yard setback variance request
Owner: Randall & Sarah Guild
Applicant: Randall & Sarah Guild
Property ID #: 05-295-025-00
Property Location: 1571 Lake Drive
Zoning District: R-1 One Family Residential

Parcel Overview and History

The parcel is located within the Silver Pines Resort subdivision and is described as Lots 25 & 26 excluding the north twenty-five (25) feet thereof. The property is zoned R-1 One Family Residential, and is located at 1571 Lake Drive, with a property number of 05-295-025-00. Adjacent properties within the subdivision and surrounding areas are also zoned R-1 One Family Residential. According to Township records and information supplied by the application, the property contains a dwelling with an attached garage along with a detached accessory building.

Request

A request has been made by the applicant/property owner for a six (6) foot variance from the ten (10) foot side yard setback, resulting in a four (4) foot setback for the proposed addition. The applicant provided a site plan showing proposed improvements along with a narrative explaining why they believe the request should be approved. Staff review has been provided in the following pages of this report.

Update 1-9-2025

The applicant informed this office that he was unable to obtain any easement or other property grant from the adjacent property to the north and has agreed to allow the Zoning Board of Appeals to act on the request. This Board tabled the variance request to give the applicant the opportunity to approach the neighboring property owner to request an easement.

**Aerial view of subject parcel and adjacent properties
(subject property is highlighted in light blue)**



- Parcels_2024
- Addresses
- Roads
- Public Right-of-Way

MITGAR24-SID-3INCH.sid

RGB

- Red: Band_1
- Green: Band_2
- Blue: Band_3

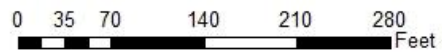

Garfield Charter Township
 3848 Veterans Drive
 Traverse City, MI 49684
 Phone: 231.941.1620
 Fax: 231.941.1688
www.garfield-twp.com



NOT A LEGAL SURVEY

Garfield Township Zoning Dept. - Printed on: 10/22/2024

This map is based on digital databases prepared by Garfield Township. The Township does not warrant, represent or imply that the information on this map is current or proportionally accurate. Always contact a surveyor for the sake of where your property lines are located.

Aerial View of the subject property

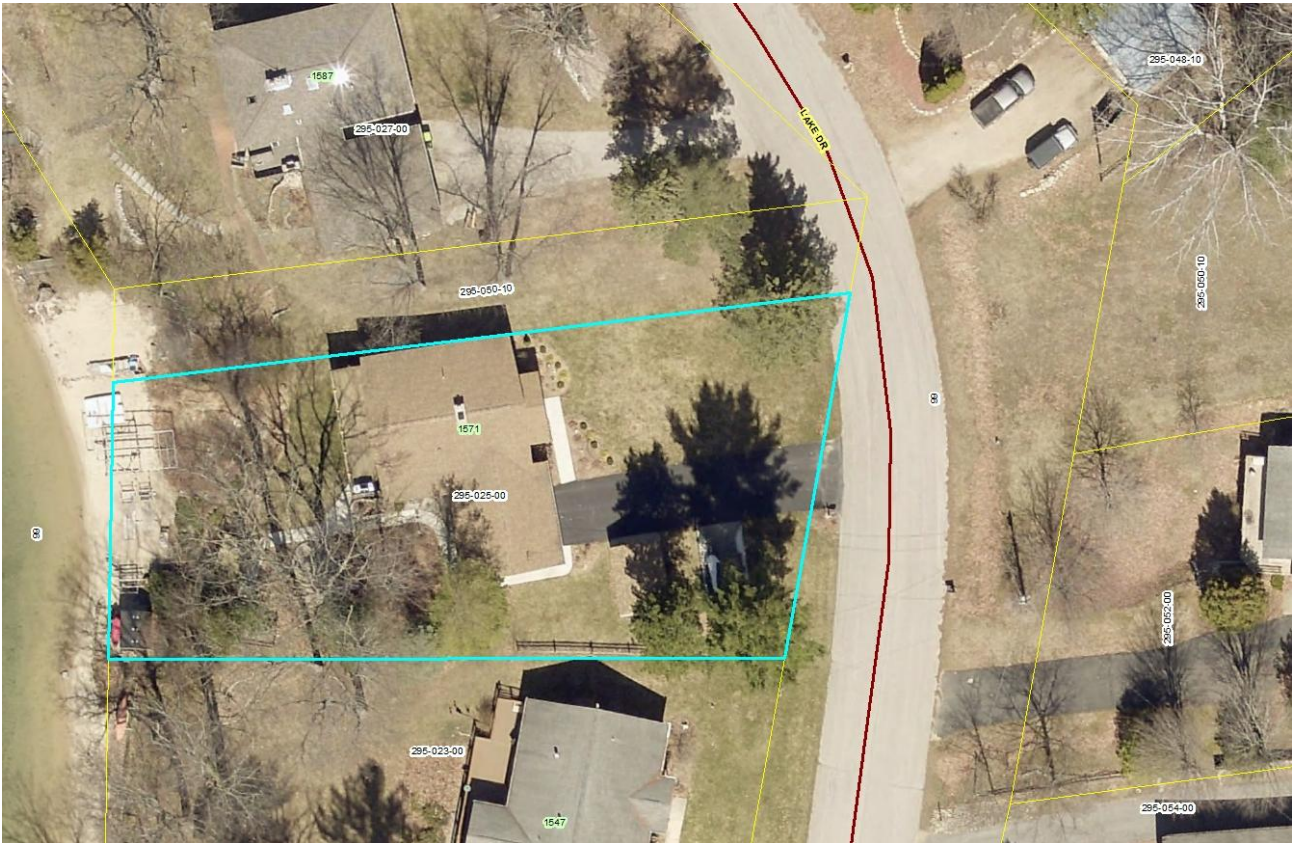

Building Sketch of the subject property from the Assessor's Office

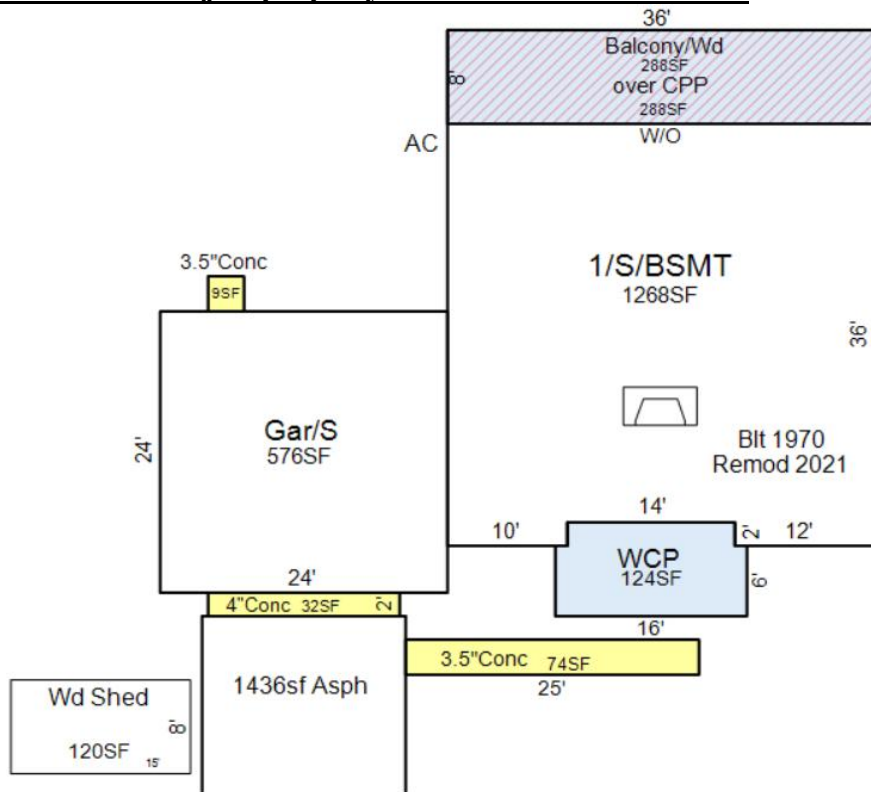

05-295-025-00

GUILD RANDALL J & SARAH S TRUSTEES 1571 LAKE DR

10/22/2024

Approval Criteria (Section 454.E)

A variance may only be granted if the Zoning Board of Appeals finds that each of the Practical Difficulty standards under Section 454.E.1 are met, each of the General Criteria under Section 454.E.2 are met, and at least one of the Special Conditions or Circumstances are met. The applicant has provided a letter written by Dusty Christiansen of Mansfield and Associates with responses to each of the approval criteria below. In addition, I have provided you with recommended findings for each Practical Difficulty standard and General Criteria below. As stated in Section 454.E, a variance can be granted only if the Zoning Board of Appeals makes **at least one finding in favor of each of these standards**.

(1) Practical Difficulty

To qualify for a dimensional variance, the applicant shall be required to show “practical difficulty” by demonstrating compliance with all the following criteria:

- a) Special conditions or circumstances exist that are peculiar to the land, buildings, or other structures for which the variance is sought, do not apply generally to lands, buildings, or other structures in the same district, and could not reasonably be addressed through the formation of general regulation for such conditions. Special circumstances or conditions to be considered for variances shall include, but not be limited to, the circumstances as described in § 454.E.(3);
 - **Staff Response in opposition:** *Although the lot meets Special Condition (c) due to the nonconforming lot width and size, staff was unable to determine any Special Conditions that prevent the applicant from complying with the R-1 District Setback requirements. In addition, the aforementioned nonconformities are somewhat common throughout the R-1 Zoning District and particularly present around Silver Lake.*
- b) The special conditions and circumstances peculiar to the land, buildings or other structures did not result from a self-created condition or action taken by the applicant or an owner of the lands;
 - **Staff Response in opposition:** *While the subject property does not meet the minimum width (100 ft. required – 96.5 ft lot width) or the minimum lot size (20,000 square foot required – 16,998 square foot property size), nonconforming lots of this type are very common in areas around Silver Lake and other areas zoned R-1.*
- c) The special conditions and circumstances are such that strict application of the provisions of this ordinance would deprive the applicant of any reasonable use of the land, building, or structure authorized by this Zoning Ordinance;
 - **Staff response in opposition:** *The strict application of the setback requirements of this Ordinance does not preclude the applicant from constructing an addition to the existing dwelling outside of the required side setback area that otherwise meets the requirements of this Ordinance. In fact, the survey provided by the applicant demonstrates that there is ample area within the required setback areas that could easily accommodate the addition.*
- d) Literal interpretation of the provisions of this ordinance would deprive the applicant of rights commonly enjoyed by other properties in the same zoning district under the terms of this ordinance;
 - **Staff response in opposition:** *The applicant has failed to adequately demonstrate that a denial of their request would deprive them of rights enjoyed by other properties in the same zoning district. As stated above, there appears to be ample buildable area toward the lake and the south lot line to expand the current dwelling that would not require any variances.*
- e) For the purpose of this section, a practical difficulty shall not exist because an applicant would incur additional costs to achieve full compliance or could receive additional income with less than full compliance with the ordinance.
 - **Staff Response in favor:** *The applicant is not claiming a financial hardship.*

(2) General Criteria

Where the applicant is able to demonstrate “practical difficulty” by satisfying all of the criteria of § 454.E.(1), a dimensional variance may be granted if it meets the following general criteria:

- (a) The requested variance shall relate only to property that is under the control of the applicant;
 - **Staff response in favor – N/A:** *The variance only relates to property under control of the applicant.*

- (b) No nonconforming neighboring lands, buildings, or other structures, legal or illegal, in the same district, and no permitted buildings, or other structures in adjacent districts, shall be considered as grounds for the issuance of a variance;
 - **Staff response in favor – N/A:** *The applicant is not asking for a variance based on any other nonconformities in adjacent properties or within the R-1 District.*
- (c) The requested variance shall be in harmony with the general purpose and intent of this ordinance and shall not be detrimental to the public health, safety and welfare;
 - **Staff response in opposition:** *The requested variance for the addition to the existing dwelling would not be detrimental to the public health, safety and welfare but could create unnecessary precedent and weaken the Zoning Ordinance as it pertains to setback requirements in the R-1 District.*
- (d) The requested variance shall not alter the essential character of the area or cause a substantial adverse effect upon properties in the immediate vicinity or in the district in which the property of the applicant is located;
 - **Staff response in opposition:** *The requested variance may impair the ability of the lot to meet stormwater management standards established by the Township Stormwater Ordinance. The Zoning Board of Appeals should carefully consider this before allowing a structure so close to a neighboring lot.*
- (e) The requested variance is the minimum variance that will make possible the reasonable use of the land, building, or structure, and there is no reasonable alternative location on the parcel for the proposed improvements for which a variance is sought where such alternative location would eliminate the need for the requested variance or reduce the extent of the condition(s) necessitating the variance.
 - **Staff response in opposition:** *The applicant has not adequately demonstrated that there is no reasonable alternative location on the parcel for the proposed improvements that wouldn't require a variance.*

(3) Special Conditions or Circumstances

Special conditions or circumstances to be considered for the purposes of § 454.E.(1) shall include, but not limited to, the circumstances as described below:

(a) Physical Conditions

The proposed project site contains physical conditions such as narrowness, shallowness, shape, or topography of the property involved that do not generally apply to other property or uses in the same zoning district.

- **Staff response in opposition:** *Although located on a platted but unbuilt cul-de-sac, the cul-de-sac does not create any unusual lot conditions such as narrowness, shallowness, shape or topography that would require relief from the front setback requirement.*

(b) Significant Vegetation or Natural Features

The proposed project site contains significant vegetation or other natural features identified as Stream environment/Wetland by the Garfield Township Master Plan.

- **Staff response in opposition:** *The subject property does not contain any streams or wetlands that would limit the available buildable area.*

(c) Substandard Lots(s)

The proposed project involved the utilization of an existing legal nonconforming lot(s).

- **Staff response in favor:** *The subject property is considered a non-conforming lot due to size and width.*

(d) Historic Resources

The proposed project site contains historical significance.

- **Staff response in opposition:** *There is no known historic designations for the subject property.*

(e) Neighborhood Character

The proposed project promotes the established historical or traditional development pattern of a blockface, including setbacks, building height, and other dimensional requirements.

- **Staff response in opposition:** *There is no clear development pattern in the blockface that promotes side yard setbacks less than the required ten (10) feet.*

Staff Comments

As you see in my staff findings for the Practical Difficulty standards and General Criteria, I was unable to make findings in favor of each standards based on information provided by the applicants. My analysis, however, is not meant to steer the Zoning Board of Appeals to deny the request or preclude the Zoning Board of Appeals from considering additional information provided by the applicant in support for each standard. I am including a chart below to assist you in reviewing the applicable standards prior to making a motion to grant or deny the request.

Review Standard	Staff Response	ZBA Determination/Comments
Practical Diff. (a)	Standard not met	
(b)	Standard not met	
(c)	Standard not met	
(d)	Standard not met	
(e)	Standard met – N/A	
Gen. Criteria (a)	Standard met – N/A	
(b)	Standard met – N/A	
(c)	Standard not met	
(d)	Standard not met	
(e)	Standard not met	

Possible Motion

Upon review of each finding, the Zoning Board of Appeals may consider a motion to take one of the following actions:

Motion to **GRANT** the request for variance from Sections 313.E of the Garfield Township Zoning Ordinance to six (6) foot variance based on findings for each Practical Difficulty standard and General Criteria for granting such request being met.

Motion to **DENY** the request for variance from Sections 313.E of the Garfield Township Zoning Ordinance to allow a six (6) foot variance based on findings for each Practical Difficulty standard and General Criteria for granting such request NOT being met.

Please feel free to contact me if you have any questions before the meeting.

Sincerely,

Michael Green, Zoning Administrator
 Charter Township of Garfield

Attachments:

1. ZBA Application and site plan
2. Section 313.E of the Zoning Ordinance (R-1 District Dimensional Standards) and Section 535 Supplemental Shoreline Regulations.



Charter Township of Garfield

Grand Traverse County

3848 VETERANS DRIVE
TRAVERSE CITY, MICHIGAN 49684
PHONE: 231-941-1620 * FAX: 231-941-1588

ZONING BOARD OF APPEALS APPLICATION

Applications and fees shall be submitted 30 days prior to the regular scheduled ZBA hearing date.

1. Owner Name:

Guild Randall J & Sarah S Trust

Address:

1571 Lake Dr

City, State, Zip Code:

Traverse City, MI 49685

Owner Phone Number:

(231) 631-7155

Applicant Name:

Randy Guild

Address:

1571 Lake Dr

City, State, Zip Code:

Traverse City, MI 49685

Applicant Phone Number:

Same

2. Property Information:

a. Property Address: 1571 Lake Dr, Traverse City, MI 49685

b. Property Location: Lots 25 & 26 EXE N 25' Silver Pines Resort

c. Lot # 25&26 EXE N 25' Subdivision Name: Silver Pines Resort

d. Parcel ID# 28-05- 295 - 025 - 00

e. Current Zoning: R-1-One-Family Residential

f. Current Use: Residential

3. Purpose For Request:

Variance Appeal Interpretation Review

Other Please explain request / list section(s) related to request: Set back variance requested along north property line to expand primary bedroom 10.5' west at the NW corner of the house. Requesting north side set back reduction to 4', to allow BR expansion west that follows existing house north wall from the E/W footprint.

Affidavit:

The undersigned affirms that he/she or they is/are the owner, or authorized agent of the owner, and that the answers and statements herein contained and the information submitted are in all respects true and correct. In addition, the undersigned represents that he/she or they is/are authorized and does hereby grant a right of entry to Township officials for the purpose of inspecting the premises and uses thereon for the sole purpose of gathering information regarding the request.

Randall J. Guilel
Owner Signature

10/16/24
Date

Applicant Signature

Date

Any party aggrieved by the decision of the Zoning Board of Appeals may appeal the decision to circuit court. An Appeal of the decision shall be filed in accordance with PA 110 of 2006, as amended.

Re: Zoning Board of Appeals Application

17October2024

Purpose of Request: Variance: x

(UPDATE)

Guild Randall J & Sarah S Trust

Variance: Set back variance requested along north property line to expand primary bedroom 10.5' west at the NW corner of the house. Requesting north side set back reduction to 4', to allow bedroom expansion west that will follow existing house north wall from the East to West foot print.

Gourdie Fraser INC, was contracted to document Ordinary HighWater Mark (OHWM) with respect to house and illustrates house location with respect to property lines and setbacks, along with the proposed primary bedroom expansion at NW corner of house.

- **NW corner of the current house is 88' from OHWM**

Visual Representation: Lots 25 & 26 EXE N 25' Silver Pines Resort

Open: 1571 Lake Dr Powerpoint File

ORDINARY HIGH WATER SKETCH

ZONING INFORMATION

PARCEL IS ZONED: R-1 - ONE-FAMILY RESIDENTIAL

MINIMUM BUILDING SETBACKS:
 FRONT - 30 FT.
 SIDE - 10 FT.
 REAR - 50 FT. FROM ORDINARY HIGH WATER MARK (OHWM)

SURVEY LEGEND

- FND IRON (AS NOTED)
- FND NAIL

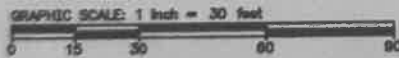
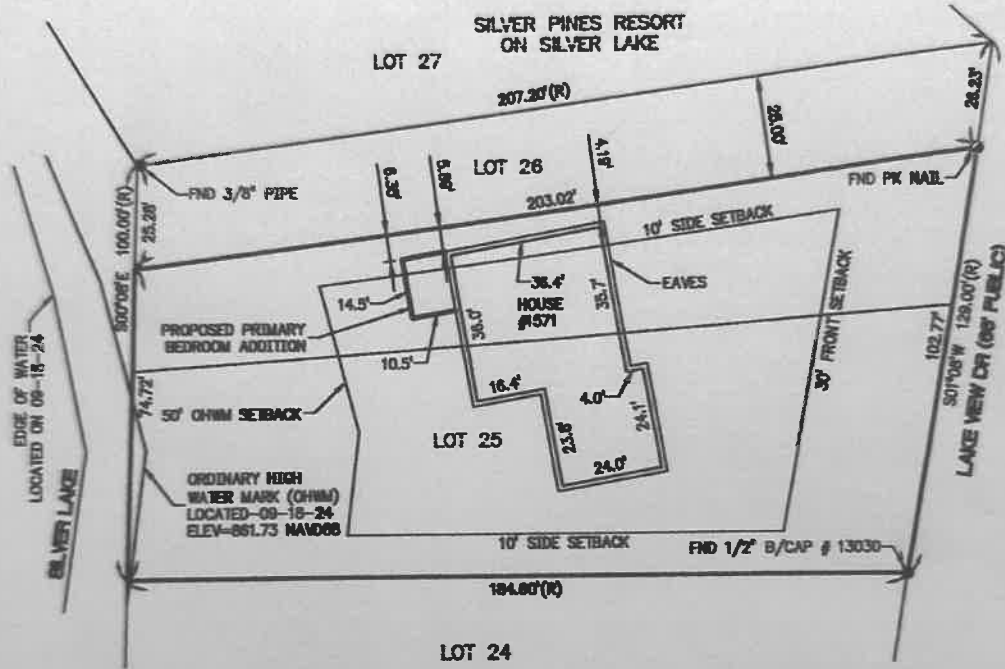

TOPOGRAPHIC SURVEY NOTES

THIS IS NOT INTENDED OR REPRESENTED TO BE A LAND SURVEY. NO PROPERTY CORNERS WERE SET AS PART OF THIS TOPOGRAPHIC SURVEY.

THE PROPERTY DESCRIPTION WAS NOT FURNISHED, AND NO CHECK OF TITLE RELATIVE TO OWNERSHIP, GAPS, OVERLAPS, OR OCCUPATION HAS BEEN PERFORMED AS PART OF THIS TOPOGRAPHIC SURVEY.

THE SURVEYOR HAS MADE NO INVESTIGATION OR INDEPENDENT SEARCH FOR EASEMENTS OF RECORD, ENCUMBRANCES, RESTRICTIVE COVENANTS, OWNERSHIP TITLE EVIDENCE OR ANY FACTS THAT AN ACCURATE AND CURRENT TITLE SEARCH MAY DISCLOSE.



PREPARED FOR: **RANDY GUILD**

BASED ON BEARING: PLAT OF SILVER PINES RESORT ON SILVER LAKE

ENGINEERING SURVEYING TESTING & OPERATIONS 123 West Front Street Traverse City, MI 49684		http://gfa.lc 231.946.5874 (p) 231.946.3703 (f)	Location: PART OF LOTS 25 & 26, OF SILVER PINES RESORT ON SILVER LAKE GOVT LOT 3, SECTION 30, TOWN 27 N, RANGE 11 W GARFIELD TWP., GRAND TRAVERSE CO., MI	Date: September 26, 2024
				Pre: A. HENRY, P.S. Scale: 25' = 1" Date: TDB 24261 SHEET 1 OF 1

THIS DOCUMENT IS PREPARED IN ACCORDANCE WITH THE TERMS AND CONDITIONS OF THE CONTRACT FOR THIS PROJECT.

E. Approval Criteria

(1) Practical Difficulty

To qualify for a dimensional variance, the applicant shall be required to show “practical difficulty” by demonstrating compliance with all of the following criteria:

(a) Special conditions or circumstances exist that are peculiar to the land, buildings, or other structures for which the variance is sought, do not apply generally to lands, buildings, or other structures in the same district, and could not reasonably be addressed through the formation of general regulation for such conditions. Special circumstances or conditions to be considered for variances shall include, but not be limited to, the circumstances as described in § 454.E.(3);

Variance of 10’ setback requested to expand primary bedroom 10.5’ in west direction. The N 25’ of Lot 26 annexed to Lots 48,49,50,51 before 1950, prior to 1571 Lake Dr home construction in 1970, per Assessors office. As the current 1571 Lake Dr property was build in 1970, the house built 4-6’ off the N25’ of Lot 26 south property line, during a timeframe that Garfield Township lacked the setbacks Requirements of today. N 25’ of Lot 26 now part of Tax Parcel 05-295-050-10(Lots 50-51) is for Silver Lake access and is nearly non-buildable with considering current setbacks of Garfield Township. Any consideration of adding a bedroom at the front of the house, may conflict with Gas line connection and water well location; thus, relocating these items would come at significant cost.

(b) The special conditions and circumstances peculiar to the land, buildings or other structures did not result from a self-created condition or action taken by the applicant or an owner of the lands;

Construction of the current 1571 Lake Drive house in 1970, put the home 4-6’ off the existing N 25’ of Lot 26 narrow lake access; therefore, the special condition variance request is not a self-created condition. The 4-6’ setback condition, may have been deemed acceptable at the time, because all local residents and Grand Traverse Township understood the 25’ lake access property attached to Lots 48,49,50,51 provided appropriate space for home construction on Lots 25 & 26.

(c) The special conditions and circumstances are such that strict application of the provisions of this ordinance would deprive the applicant of any reasonable use of the land, building, or structure authorized by this Zoning Ordinance;

Enforcement of the 10' setback along with current Tax Parcel ID#: 28-05-295-025-00 Lot26 EXE N 25'north property line would prevent any bedroom expansion directly west. New bedroom expansion would be OK, if 4' setback was approved. While the SW corner/North Side Garage Primary Bedroom/Bath addition might be possible on the existing land/building, the cost to build all items referenced in "E. (1) e." would be too extreme on a fixed retirement income. In addition, any consideration of adding a primary bedroom at the front of the house, may conflict with natural gas line connection and water well location; thus, relocating these items would come at significant cost (ie +10-15K). Also, excavation and a new foundation would also be required for any added bedroom addition off the front of the house, at significant cost.

(d) Literal interpretation of the provisions of this ordinance would deprive the applicant of rights commonly enjoyed by other properties in the same zoning district under the terms of this ordinance; and

The existing house location only 4-6' off Lot26(EXE N 25') north property line would deprive the owner from expanding the bedroom due west. Consideration that the N 25' of Lot26 is nearly non-buildable without significant variance adjustments and Garfield Township Zoning Board approvals, this should provide merit to allow a variance of the 10' north side setback to be reduced to 4'.

(e) For the purpose of this section, a practical difficulty shall not exist because an applicant would incur additional costs to achieve full compliance or could receive additional income with less than full compliance with the ordinance.

The applicant pursued purchase of the 25' North section of Lot26 and/or partial land acquisition at significant cost, but the current owner hasn't been willing to sell. To achieve full compliance with 10' side setbacks on the existing property boundaries, an additional Primary Bedroom creation would need to be

positioned at the SW corner/North garage wall of the house. A Primary Bedroom/full bath at this location would require hill side excavation lakeside of the house, a completely new foundation, new bedroom structure with significant extension & rebuild of the roof, expansion of heating baseboard system, relocation of air conditioning mini-split system, and running new plumbing and septic drain for a full bath, across the ceiling of a completely finished basement. Considering all of the changes to incorporate a bedroom/full bath off the SW corner, we would estimate to cost might be 2-3X's the cost of an expanded existing Primary Bedroom at the NW corner, which already has full bathroom access off the room. On a retired fixed income, 2-3X's the cost would not be affordable.

(2) General Criteria

Where the applicant is able to demonstrate "practical difficulty" by satisfying all of the criteria of § 454.E.(1), a dimensional variance may be granted if it meets the following general criteria:

(a) The requested variance shall relate only to property that is under the control of the applicant;

The requested north property line setback variance shall only apply to Lots 25 & 26 EXE 25' Silver Pines Resort, owned by Guild Randall J & Sarah S Trust.

(b) No nonconforming neighboring lands, buildings, or other structures, legal or illegal, in the same district, and no permitted buildings, or other structures in adjacent districts, shall be considered as grounds for the issuance of a variance;

No nonconforming neighboring lands, buildings, or other structures shall be considered as grounds for the issuance of a variance. Only the Primary Bedroom expansion 10.5' due west at NW corner of the house will be considered, contingent upon north side setback reduction variance approval.

(c) The requested variance shall be in harmony with the general purpose and intent of this ordinance and shall not be detrimental to the public health, safety and welfare;

The requested setback variance for the north property line shall be in harmony and intent of this ordinance, with the original intent of Lot 26 in Silver Shores Resort. The Primary Bedroom extension only west off NW corner will not change or alter the northern wall of the home, thus the existing lake access property (N 25' of Lot 26) will remain unchanged. The Ordinary High Water Mark sketch attached on page 2 of this document shows how the latitude position of the north wall of the house will not change.

(d) The requested variance shall not alter the essential character of the area or cause a substantial adverse effect upon properties in the immediate vicinity or in the district in which the property of the applicant is located; and

The requested setback variance should not cause an adverse effect upon properties in the immediate vicinity. The bedroom expansion west at the NW corner will follow East/West line of the current house and extends over the existing deck location. In addition, the bedroom expansion will not alter the westward view of the lake; thus, negligible impact of property values in the immediate vicinity.

(e) The requested variance is the minimum variance that will make possible the reasonable use of the land, building, or structure, and there is no reasonable alternative location on the parcel for the proposed improvements for which a variance is sought where such alternative location would eliminate the need for the requested variance or reduce the extent of the condition(s) necessitating the variance.

The requested 4' north side setback is the minimum variance that will make use of the land, building, or structure. Adding a Primary bedroom at SW corner/North garage wall would be only option to avoid need for variance request. But, to achieve full compliance with available 10' side setbacks on the land, an additional Primary Bedroom creation would incur significant cost. A

Primary Bedroom/full bath at this location would require hill side excavation lakeside of the house, a completely new foundation, new bedroom structure with significant extension of the roof, expansion of heating baseboard system, relocation of air conditioning mini-split system, and running new plumbing and septic drain for a full bath, across the ceiling of a completely finished basement. Considering all of the changes to incorporate a bedroom/full bath off SW corner, we would estimate the cost might be 2-3X's the cost of an expanded existing Primary Bedroom, which already has full bathroom access off the room. On a retired fixed income, 2-3X's the cost would not be affordable.

(3) Special Conditions or Circumstances

Special conditions or circumstances to be considered for the purposes of § 454.E.(1) shall include, but not be limited to, the circumstances as described below:

(a) Physical Conditions: The proposed project site contains physical conditions such as narrowness, shallowness, shape, or topography of the property involved that do not generally apply to other property or uses in the same zoning district.

The narrowness of the north 25' section of Lot26 makes it very difficult for structures to be built due to current set back limits for Garfield Township; therefore, Lots 25 & 26 EXE N 25' Silver Pines Resort setback variance of 4' for north property line should be considered. Yes, the owner of narrow N25' of Lot26, could also request a variance for set back reduction, but it seems highly unlikely that the township board would permit building construction knowing a home wall could be sitting 3-10' away.

(b) Significant Vegetation or Natural Feature: The proposed project site contains significant vegetation or other natural features identified as Stream Environment/Wetland by the Garfield Township Master Plan.

N/A: The Proposed project site does not include natural features identified as Stream Environment/Wetland.

(c) Substandard Lot(s): The proposed project involves the utilization of an existing legal nonconforming lot(s).

N/A: The proposed project does not involve the utilization of an existing legal nonconforming lot.

(d) Historic Resources: The proposed project site contains historical significance.

N/A: The proposed project site does not contain historical significance.

(e) Neighborhood Character: The proposed project promotes the established historic or traditional development pattern of a blockface, including setbacks, building height, and other dimensional requirements.

N/A: The proposed project promotes a traditional development pattern of a ranch design house, along with vinyl siding and roofing colors that will match the existing house. The bedroom expansion westward at NW corner would increase the home taxable value for Garfield Township and more than likely increase the property values of the homes in the general vicinity on Lake Drive along Silver Lake.

Zoning Board of Appeals Application

Purpose of Request: Variance

1571 Lake Drive

Guild Randall J & Sarah S Trust

17October2024

1571 Lake Dr Tax Parcel: 05-295-050-10, Lots 25 & 26 EXE N 25' Silver Pines Resort

The screenshot shows an aerial view of a residential area with several houses. A red arrow points to a specific parcel, 1571 Lake Dr, which is highlighted in green. A popup window is open over this parcel, displaying the following information:

Tax Parcel: 05-295-025-00	1571 LAKE DR
Site Address	TRVERSE CITY, MI 49685
Site City/State/Zip	GUILD RANDALL J & SARAH S TRUSTEES
Owner Name 1	GUILD RANDALL J & SARAH S TRUST
Owner Name 2	1571 LAKE DR
Mailing Address	TRVERSE CITY
Mailing City	MI
Mailing State	49685
Mailing Zip	Garfield Township
Mailing Zip+4	05
Tax District Description	
Tax District Code	

At the bottom of the screen, there is a search bar with the text "Find address or tax ID", a search icon, and a search button. The bottom right corner shows the weather as "45°F Mostly cloudy" and the time as "7:30 PM 10/14/2024".

1571 Lake Dr Tax Parcel: 05-295-050-10, Lots 25 & 26 EXE N 25' Silver Pines Resort

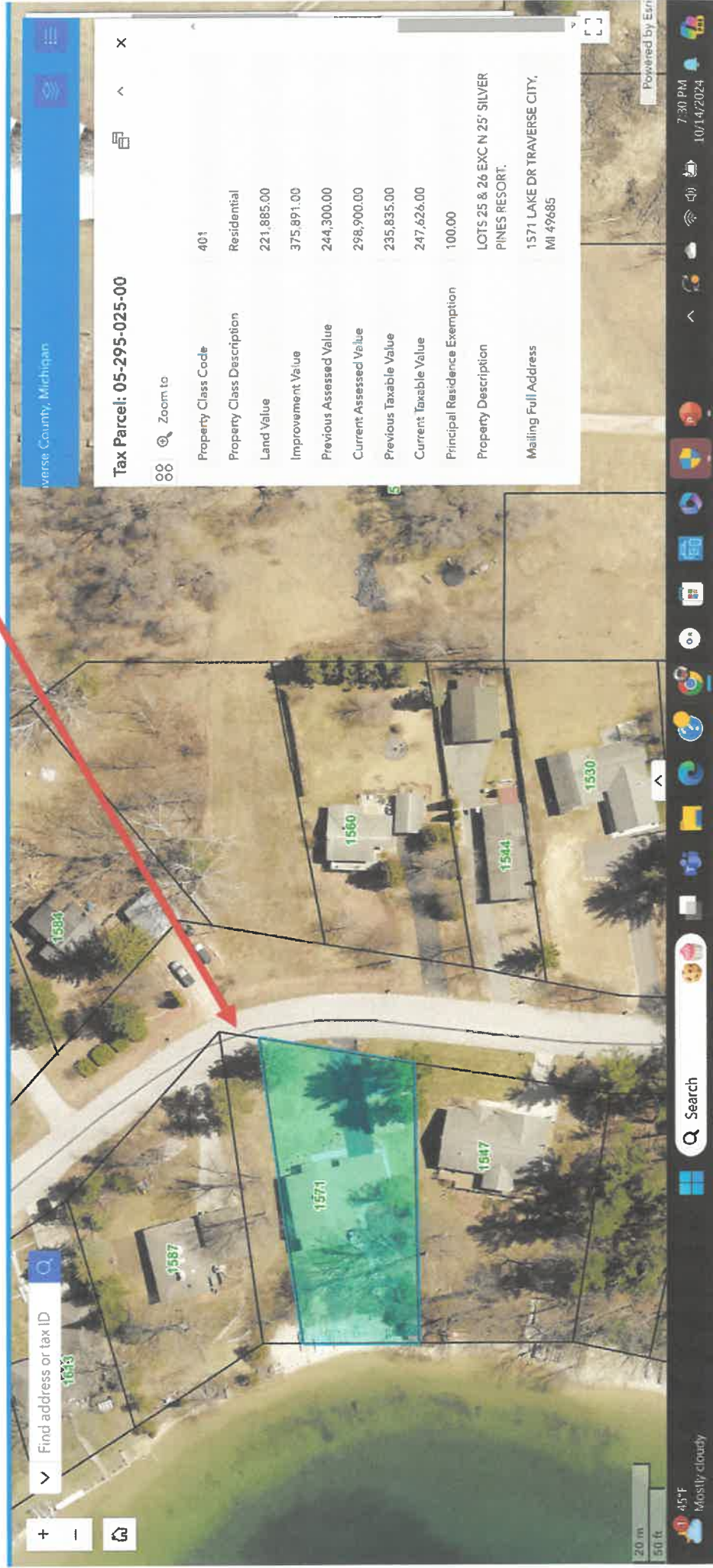

Tax Parcel: 05-295-050-10 Lots 50 & 51 & NLY Lot26 Silver Pines Resort

Garfield Map Center

Online GIS map and data hub for the Charter Township of Garfield, Grand Traverse County, Michigan

Find address or tax ID

Tax Parcel: 05-295-050-10

Zoom to

Site Address	LAKE DR
Site City/State/Zip	TRAVERSE CITY, MI 49685
Owner Name 1	CANFIELD ARTHUR R III & MICHELE K
Owner Name 2	
Mailing Address	2726 ROCK CT
Mailing City	TRAVERSE CITY
Mailing State	MI
Mailing Zip	49684
Mailing Zip+4	-7596
Tax District Description	Garfield Township
Tax District Code	05
School District Description	TRAVERSE CITY SCHOOL DIST.

20 m
50 ft

Powered by Esri

Tax Parcel: 05-295-050-10 Lots 50 & 51 Silver Pines Resort 25' Lot 26 Silver Pines Resort

Garfield Map Center

Online GIS map and data hub for the Charter Township of Garfield, Grand Traverse County, Michigan.

Find address or tax ID

20 m / 50 ft

Tax Parcel: 05-295-050-10

Principal Residence Exemption: 0.00

Property Description: LOTS 50 & 51 SILVER PINES RESORT EXC COM NELY COR LOT 50 TH S 70DEG 31'36"W 134.43' TO POB TH S 70DEG 31'36"W 43.35' TH S 09DEG 20'56"W 22.11' TH N 50DEG 47'38"E 57.38' TO POB & PRT LOT 49 COM SE'LY COR LOT 49 TH S 70DEG 31'36"W 134.43" TH N 50DEG 47'38"E 128.12' TH S 37DEG 12'29"E 45.41' TO POB & NLY 25' LOT 26 SILVER PINES RESORT SPLIT/COMBINED ON 08/05/2020 FROM 05-295-048-00; INTO 05-295-048-10; 05-295-050-10;

Mailing Full Address: 2726 ROCK CT TRAVERSE CITY, MI 49684-7596

Powered by Esri

SECTION 313 R-1 (ONE FAMILY RESIDENTIAL)

PURPOSE – The R-1 (One Family Residential) districts provide areas for low to medium density one family residential dwelling units. The districts include areas of existing one family developments as well as areas within which such development appears likely and desirable. They are intended to encourage more intensive development in and near the core areas of the township with less intensive development moving outward towards the more rural and remote areas of the township. The R-1 districts are designed to encourage a suitable neighborhood environment for family life by including among the permitted uses such facilities as schools and parks that will promote a sense of community and urban vitality.

A. USES PERMITTED BY RIGHT:

- (1) Adult Foster Care, Family Home
- (2) Cemetery
- (3) Dwelling, Single Family
- (4) Essential Service Facility, Minor – § 737.A
- (5) Home Occupation
- (6) Park, Mini
- (7) Park, Neighborhood
- (8) Solar Energy System, Accessory – § 773.A

B. USES PERMITTED BY SPECIAL CONDITIONS:

- (1) Child Care, Family Home (<7) – § 718
- (2) Child Care, Small Group Home (7-12) – § 719
- (3) Golf Course or Country Club – § 749
- (4) Keeping of Chickens, Personal – § 754.A
- (5) Medical Marihuana Residential Cultivation – § 758
- (6) Open Space Preservation – § 428
- (7) Outdoor Storage, Accessory Use – § 613.A (4)
- (8) Recreational Field Complex – § 766
- (9) Swimming Pool, Private – § 776
- (10) Waterfront Stairways and Landings – § 778

C. USES PERMITTED BY SPECIAL USE PERMIT:

- (1) Adult Foster Care, Small Group Home – § 708
- (2) Essential Service Facility, Major – § 737.B
- (3) Institutional Uses and Structures – § 752
- (4) Solar Energy System, Primary – § 773.B
- (5) Wind Energy Conversion System, Personal – § 781

D. ADDITIONAL STANDARDS:

- (1) Driveways for single family residences shall comply with § 511.
- (2) Completion. Any single-family dwelling, accessory building or addition thereto must be completed on the exterior surface with a suitable finishing material including painting or staining in the case of wood, within two (2) years from date of issuance of a land use permit or one (1) year from the date of occupancy whichever occurs last.

E. DIMENSIONAL STANDARDS (Per Dwelling Unit):

Minimum Lot Area (A):

- With Public Sewer: 15,000 sq. ft.
- Without Public Sewer: 20,000 sq. ft.

Notes to Dimensional Standards:

- (A) Lots in subdivisions having stubbed sewers shall be considered as having public sewer.
- (B) Setbacks shall be measured from the furthest protruding point of structure.

Minimum Lot Width:

100 feet

Maximum Building Height:

- In Stories: 2 ½ stories
- In Feet: 35 feet

Minimum Yard Setbacks (B):

- Front: 30 feet
- Each Side: 10 feet
- Rear: 30 feet

Maximum Lot Coverage:

30 percent

Minimum Bldg. Cross Section:

24 feet

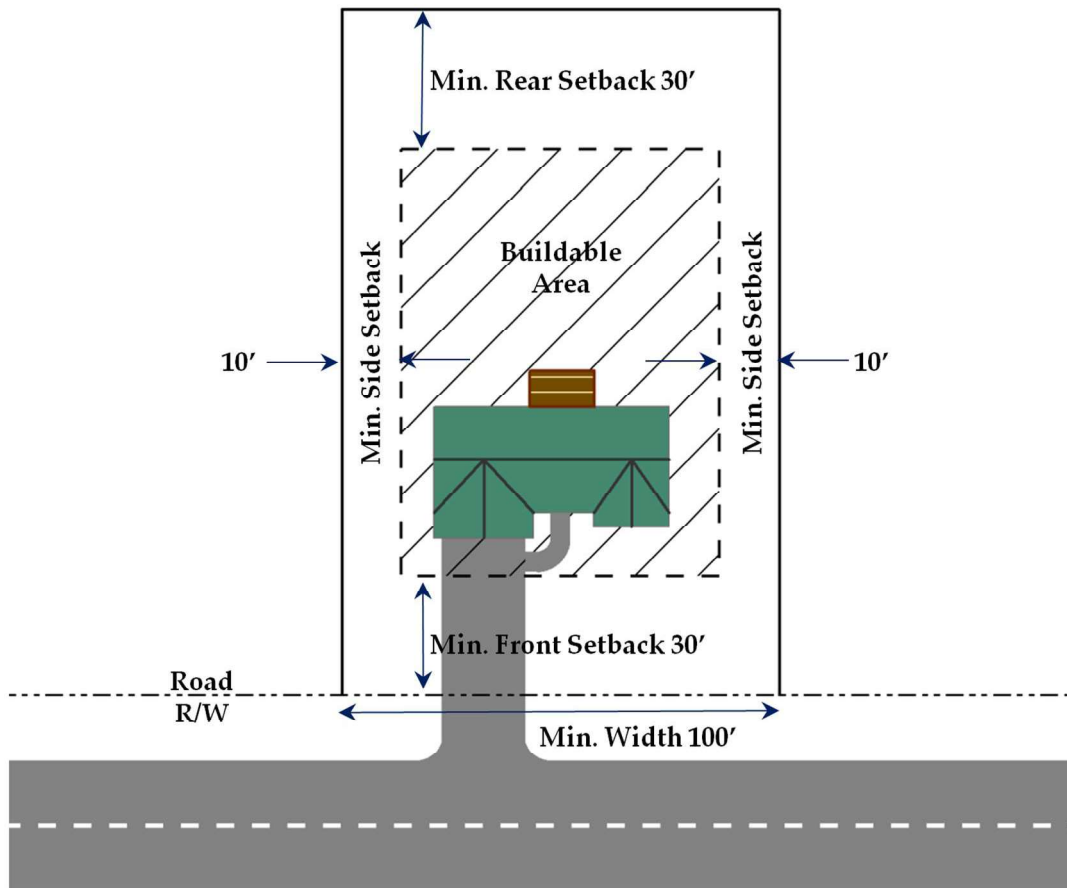

Not to scale. To be used for illustrative purposes only

SECTION 535 SUPPLEMENTAL SHORELINE REGULATIONS

Purpose. The intent of this Section is to preserve and protect the water quality of the lakes and streams of our region. These regulations seek to balance the protection of the ecosystem while allowing development where appropriate. Methods to accomplish this purpose include, but are not limited to, preservation and/or enhancement of vegetation along lake-stream banks, maintaining lake-stream bank stabilization, preventing sediment from entering the water bodies, allowing for nutrient absorption, providing wildlife habitat and corridors, screening man-made structures, and providing shade, wood or wooden fiber material along the shoreline.

A. Setbacks from Lakes, Rivers, and Streams

- (1) Every commercial, industrial or multi-family residential building hereafter erected having frontage on any body of water, with the exception of Silver and Boardman Lakes, and with the exception of on-site storm water ponds and artificial water bodies created as part of the site's landscape treatment, shall be set back at least seventy-five (75) feet from the watermark or normal stream bank. Single family residential uses shall observe a setback of fifty (50) feet. Along those sections of the Boardman River controlled under the Natural River Act, PA 231 of 1970, as amended, setbacks shall be as required by the Act.
- (2) Every building hereafter erected having frontage on Silver and Boardman Lakes shall set back at least fifty (50) feet from the water mark.
- (3) Storm water retention or detention ponds, with the exception of customary release structures including pipe, swales and ditches shall be set back fifty (50) feet from a natural lake or normal stream bank.
- (4) Streets and access drives other than where they intersect lakes or streams and for such a distance as is required to cross a lake or stream shall be set back fifty (50) feet from a watermark or normal stream bank.

B. Minimum Construction Elevations - Silver Lake

Within five hundred (500) feet of Silver Lake, the lowest grade for any building construction or accessory building construction shall be elevation 866.N.V.G.D. (NOTE- SILVER LAKE WATER MARK - 862.32 feet above sea level USGSD).

C. Riparian Vegetative Buffers

- (1) Required. A vegetated buffer strip shall parallel and extend thirty-five (35) feet inland from all points along the water mark of a lake-stream shoreline or normal stream bank, with the exception of on-site storm water ponds and artificial water bodies created as a part of site landscape treatment which does not flow or overflow into a natural lake-stream. The general standards for the buffer strip are as follows:
 - (a) The buffer strip shall consist of native trees, shrubs and other vegetation. Dead, diseased, unsafe or fallen trees and noxious plants and shrubs, including poison ivy, poison sumac and poison oak, may be removed. Trees and shrubs shall not be removed but may be pruned for a filtered view of the lake-stream, however, clear cutting shall be prohibited.
 - (b) Subject to (1) above; ground cover vegetation shall be left in a natural state and shall not be removed. Chemical control and/or fertilization of vegetation shall be prohibited.
 - (c) Footpaths, bicycle paths and hiking paths as well as fences, walls and stairways may be constructed under the following conditions:
 - (i) All paths and stairways must be constructed in a location and manner to avoid soil and slope failure.

- (ii) Construction shall avoid removal of existing trees, shrubs and any other vegetation whenever feasible.
- (2) Reduction. In the event that the application of the vegetated buffer strip standards of this Section, together with any other dimensional restrictions applicable under this Ordinance, results in a legal parcel that cannot be reasonably developed for permitted land uses in the district within which the property is located, the Planning Commission may approve a reduction of the buffer area upon a finding that the proposed site plan provides the maximum possible buffer strip, while permitting a reasonable use of the property.

D. Filling and Grading within 200 Feet of the Water Mark or Stream Bank

The following rules shall apply to any filling, grading or any other earth movement within 200 feet of the water mark or normal stream bank of any lake, river, stream, or other body of water to prevent harmful erosion and related sedimentation:

- (1) The smallest amount of bare ground shall be exposed for as short a time as feasible.
- (2) Temporary ground cover such as mulch must be used as soon as possible and permanent cover such as sod be planted.
- (3) Diversions, silting basins, terraces and other methods must be used to trap any sediment.
- (4) Fill must be stabilized according to accepted engineering practices.



Charter Township of Garfield

Grand Traverse County

3848 VETERANS DRIVE
 TRAVERSE CITY, MICHIGAN 49684
 PH: (231) 941-1620 • FAX: (231) 941-1588

JOE McMANUS
SUPERVISOR

LANIE McMANUS
CLERK

CHLOE MACOMBER
TREASURER

MOLLY AGOSTINELLI, *TRUSTEE*
 CHUCK KORN, *TRUSTEE*

LAURIE LAPP, *TRUSTEE*
 DENISE SCHMUCKAL, *TRUSTEE*

2025 Zoning Board of Appeals Meeting Dates

The Zoning Board of Appeals meets on an “as needed” basis. If necessary, the regular meeting dates of the Garfield Township Zoning Board of Appeals are scheduled the third Thursday of each month, beginning at 6:00pm. in the Large Meeting Room of the Township Offices located at 3848 Veterans Drive, Traverse City, Michigan.

January 16, 2025
 February 20, 2025
 March 20, 2025
 April 17, 2025
 May 15, 2025
 June 19, 2025
 July 17, 2025
 August 21, 2025
 September 18, 2025
 October 16, 2025
 November 20, 2025
 December 18, 2025

Garfield Township will provide necessary reasonable auxiliary aids and services, such as signers for hearing impaired and audio tapes of printed materials being considered at the meeting to individuals with disabilities upon the provision of reasonable advance notice to the Township. Individuals with disabilities requiring auxiliary aids or services should contact the Garfield Township Clerk, Lanie McManus in writing or calling, (231) 941-1620.